



**2024-25**

**PRODUCT CATALOGUE**



Follow us on :



@yorkertools

 [www.yorkertoolscentre.com](http://www.yorkertoolscentre.com)



## about us

Welcome to Yorker. A brand, which inculcates the tradition of professionalism and brand value while serving premium quality hardware tools to the world. Established in the year 2014, Yorker is not just a name but a brand as one of the largest manufacturer of measuring tapes in India.

While being one of the largest stockiest of Abrasives, Power Tools and Accessories in the Indian-subcontinent; Yorker instigates the urge of premium quality hardware tools in the market with the best possible prices.

With state of the art infused powered manufacturing plants, Yorker is climbing the ladder of success focusing on Research and Development along with continuous technical up-gradations to serve the latest and the best possible hardware tools. Our entire team of 500+ members continues to deliver happiness with premium quality hand tools, power tools and spare parts for machine and accessories.

With Steel and Fiber Measuring Tapes, we at Yorker deals with mostly all the other segments of hardware tools whether it be Abrasives, Drill Bits, TCT Saw Blades, Diamond Saw Blades, Cup Wheels, Screw Drivers and other Accessories including Bits, Saws, Snips, Pliers and many more. Yorker's newly launched Power Tools Segment includes Drill Chucks, Carbon Brushes, AB Washers, Gears and much more.

While offering an exceptional mix of modernity, design, ease of use, great range along with competitive pricing; "We" stand out from the crowd and to continue with this growth, we utmost spend majority of our time in the R&D to make sure that our entire product range complies with the best Industrial Standards.

Over the years, we have become the most trusted as well as favourite when supplying the engineering community with the supplies it needs to get the job done. Our World-Class Standards define our success as the front runner in the Hardware Tool Industry. Our management works on a binary chart wherein the up-gradation never stops and the demand-supply chain is not a hassle.

Yorker welcomes you onboard and promises you to give you huge profits with the rarest combination of competitive prices and premium quality.





<b>Page :1-2</b>	Steel Mesuring Tape
<b>Page :3</b>	Fiberglass Mesuring Tape
<b>Page :4</b>	Laser Distance Meter
<b>Page :5</b>	Magnetic or Non Magnetic Level
<b>Page :6-14</b>	Power Tools
<b>Page :15-16</b>	Abrasives
<b>Page :17-18</b>	Polishing Products
<b>Page :19</b>	Drill Bits
<b>Page :20</b>	TCT Saw Blades
<b>Page :21-22</b>	Diamond Saw Blade & Cup Wheels
<b>Page :23-24</b>	Super Thin Turbo & Zero Chipping
<b>Page :25</b>	Screw Drivers
<b>Page :26</b>	Wood Working Accessories
<b>Page :27-31</b>	Accessories
<b>Page :32-33</b>	Gardening Tools
<b>Page :34-35</b>	Others Accessories

# CONTENTS

## TABLE OF

Item Code: 8001



- SPECIFICATIONS -

**Y - Series**

Y-16 (3mtr. x 16mm)  
Y-19 (5mtr. x 19mm)

- With Belt Clip
- Unbreakable ABS Case
- Wider End Hook 3 Rivets
- Zipper Lock 1 Pc. Packing

Item Code: 8002



- SPECIFICATIONS -

**Eco - Series**

3mtr. x 13mm  
3mtr. x 16mm  
5mtr. x 19mm

- With Belt Clip
- Unbreakable ABS Case
- Wider End Hook 3 Rivets
- Compact Body

Item Code: 8004



- SPECIFICATIONS -

**India's Most Compact Case  
Perfect - Series**

3mtr. x 13mm  
3mtr. x 16mm  
5mtr. x 19mm

- With Belt Clip
- Unbreakable ABS Case
- Wider End Hook 3 Rivets

Item Code: 8007



- SPECIFICATIONS -

**Transparent Body**

3mtr. x 16mm  
5mtr. x 19mm

- With Belt Clip
- Transparent ABS Case
- Non-Slip end Hook
- Compact Design

Item Code: 8009



- SPECIFICATIONS -

**First Choice**

3mtr. x 16mm  
5mtr. x 19mm

- ABS Case
- Compact Design
- High standout
- High performance blade
- A pleasant hand feeling, stable and comforting in stretching and extracting

Item Code: 8010



- SPECIFICATIONS -

**Neo Lock**

3mtr. x 16mm  
5mtr. x 19mm

- ABS Case
- Compact Design
- High standout
- High performance blade
- A pleasant hand feeling, stable and comforting in stretching and extracting
- Non-slip end hook

Item Code: 8112



- SPECIFICATIONS -

**Jupiter**

3mtr. x 16mm  
5mtr. x 19mm

- ABS Case
- Compact Design
- High standout
- High performance blade
- A pleasant hand feeling, stable and comforting in stretching and extracting
- Non-slip end hook

Item Code: 8113



- SPECIFICATIONS -

**Yorker Autostop**

5mtr. x 19mm

- ABS Case
- Compact Design
- High standout
- High performance blade
- A pleasant hand feeling, stable and comforting in stretching and extracting
- Non-slip end hook

Item Code: 8110



- SPECIFICATIONS -

**Steel Strip & Spring**

3mtr. x 16mm  
5mtr. x 19mm



# STEEL MEASURING TAPES

Item Code: 8087



NEW ARRIVAL

## - SPECIFICATIONS -

### Yorker 2 in 1

3mtr. x 16mm  
5mtr. x 19mm

- Compact Design
- High standout
- High performance blade

Item Code: 8080



NEW ARRIVAL

## - SPECIFICATIONS -

### Yorker Pro

Pro-16  
Pro-19

- Compact Design
- High standout
- High performance blade

Item Code: 8005



## - SPECIFICATIONS -

India's Most Compact Case  
Black White - Series

3mtr. x 16mm  
5mtr. x 19mm

- With Belt Clip
- Unbreakable ABS Case
- Wider End Hook 3 Rivets

Item Code: 8084



## - SPECIFICATIONS -

### Auto lock

3mtr. x 16mm  
5mtr. x 19mm

- Compact Design
- High standout
- High performance blade

## STEEL MEASURING TAPES

A steel measuring tape is a flexible ruler used to measure distance. It consists of a metal blade with linear-measurement.



# FIBERGLASS TAPES

Item Code: 8011



- SPECIFICATIONS -

**Fiberglass Grey Body**

Size : 7.5 / 10 / 15 / 30 / 50mtr.

Item Code: 8014



- SPECIFICATIONS -

**First Choice Fiberglass**

Size : 15 / 30mtr.

Item Code: 8015



- SPECIFICATIONS -

**Yorker Glaxo Fiberglass**

Size : 15 / 30mtr.

Item Code: 8018



- SPECIFICATIONS -

**Fiberglass Perfect (3D / Radium Colour Refill)**

Size : 7.5 / 10 / 15 / 30 / 50mtr.

Item Code : 8020

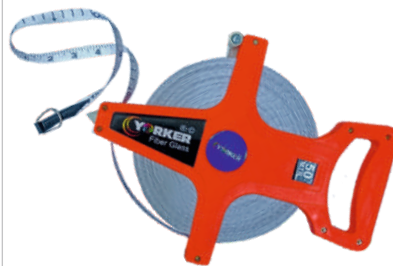

- SPECIFICATIONS -

**Yorker Open-Reel Fiberglass Tape**

Size : 50mtr.

Item Code: 8019



- SPECIFICATIONS -

**Fiberglass Refill**

Size : 7.5 / 10 / 15 / 30 / 50mtr.

Item Code : 8038



NEW ARRIVAL

- SPECIFICATIONS -

**Pro Fiberglass Measuring Tape**

Size: 15 / 30mtr

## Fiberglass Tapes

Fiberglass measuring tapes are made of fiberglass threads cast in plastic. They are flexible, lighter.



Code : LDM-40/60/80



- Area Measurement
- Volume Measurement
- Wall Measurement
- Min. / Max. Function
- Angle Measurement
- Addition / Substraction
- Fast Read of Distance
- Record Groups of Data
- With Tilt Sensor and Auto Level

Code : SA-02CR

## CROSS LASER LEVEL



- Quality product, handy and easy to use
- One person does the job of two people using manual plumb bob
- TPE cover for drop proof protection
- Connect with 1/4" tripod, L frame and clip frame







## MAGNETIC OR NON MAGNETIC LEVEL

Item Code: 9053



### PVC Level



### - SPECIFICATIONS -

PVC Level  
Size : 4", 9", 12"

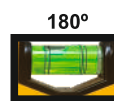
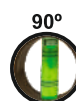

ACCURACY  
0.057° = 1.0mm/m  
In Normal Position

Item Code: 9054

### ALUMINIUM LEVEL

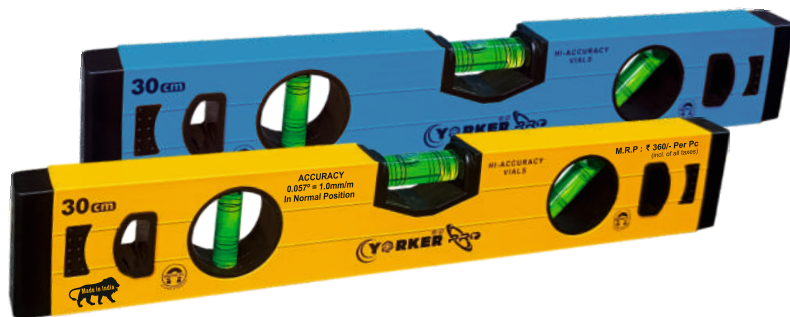

### Magnetic Spirit Level



Heavy Duty Aluminium Profile



Shock Absorbent End Caps



Proudly Made in India

### - SPECIFICATIONS -

Professional Aluminium Level  
Size : 15cm To 200cm  
(6" to 80" appx.)  
Vials with 2vial 3vial and 4vial

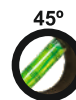
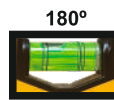
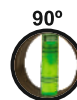

ACCURACY  
0.057° = 1.0mm/m  
In Normal Position

### MAGNETIC OR NON MAGNETIC LEVEL

"Introducing our precision-crafted Level, the ultimate tool for achieving accurate measurements and optimal alignments. Engineered with Accuracy, our levels offer exceptional stability and longevity. Designed for professionals, our aluminum levels feature a sleek profile, easy-to-read bubble vials, and reliable accuracy. Whether you're working on construction projects, carpentry, or home improvements, our Aluminum Level ensures your work is perfectly level and aligned every time."



**YK-2310 10MM DRILL MACHINE**



ITEM CODE	8501
FREQUENCY	50/60HZ
VOLTAGE	220/230V
INPUT POWER	450
NO LOAD SPEED	2600
DRILLING CAPACITY	10

**YK-2310A DCA 10MM DRILL MACHINE**



ITEM CODE	8502
FREQUENCY	50/60HZ
VOLTAGE	220/230V
INPUT POWER	500
NO LOAD SPEED	0-4500
DRILLING CAPACITY	10

**YK-2310 10MM DRILL MACHINE**



ITEM CODE	8503
FREQUENCY	50/60HZ
VOLTAGE	220/230V
INPUT POWER	450
NO LOAD SPEED	2600
DRILLING CAPACITY	10

**YK-13B 13MM IMPACT DRILL**



ITEM CODE	8504
FREQUENCY	50/60HZ
VOLTAGE	220/230V
INPUT POWER	600
NO LOAD SPEED	0-2600
DRILLING CAPACITY	13

**YK-2-20/2-26 ROTARY HAMMER**



ITEM CODE	8505
FREQUENCY	50/60HZ
VOLTAGE	220/230V
INPUT POWER	800 W
NO LOAD SPEED	850 RPM
DRILLING CAPACITY	20 MM

**YK-10B SCREW DRIVER 10B**



ITEM CODE	8506
FREQUENCY	50/60HZ
VOLTAGE	220/230V
INPUT POWER	350
NO LOAD SPEED	0-1100
DRILLING CAPACITY	10

**YK-10C SCREW DRIVER 10C**



ITEM CODE	8507
FREQUENCY	50/60HZ
VOLTAGE	220/230V
INPUT POWER	400
NO LOAD SPEED	0-1100
DRILLING CAPACITY	10

**YK4SB**
**MARBLE CUTTER YK4SB**

**YK4SA**
**MARBLE CUTTER YK4SA**

**YKCM5**
**Cm5 MARBLE CUTTER**

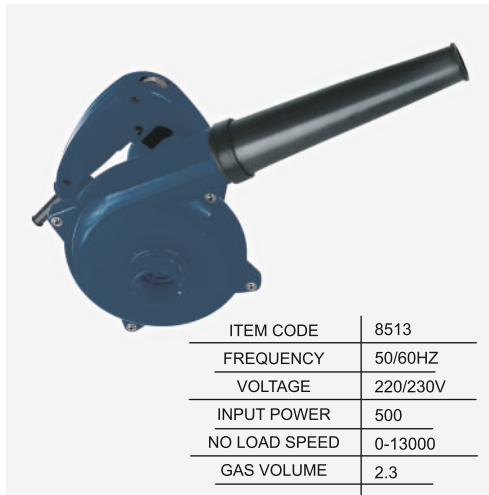
**YK-28EV**
**28 EV ELECTRIC BLOWER**

**YK-70JS**
**70mm ELECTRIC ZIG SAW**

**YK-12ER**
**ELECTRIC ROUTER 12ER**

**YK-65**
**Ph65 DEMOLITION HAMMER**

**YK-180P**
**ELECTRIC POLISHER**

**YK-0835**
**DEMOLITION HAMMER**

## ANGLE GRINDER YK6100



ITEM CODE	8518
FREQUENCY	50/60HZ
VOLTAGE	220/230V
INPUT POWER	800
NO LOAD SPEED	11000 RPM
WHEEL DIAMETER	100 MM

## ANGLE GRINDER YK801



ITEM CODE	8519
FREQUENCY	50/60HZ
VOLTAGE	220/230V
INPUT POWER	850
NO LOAD SPEED	11000 RPM
WHEEL DIAMETER	100 MM

## ANGLE GRINDER YK802



ITEM CODE	8520
FREQUENCY	50/60HZ
VOLTAGE	220/230V
INPUT POWER	850W
NO LOAD SPEED	11000 RPM
WHEEL DIAMETER	100 MM

## DEMOLITION HAMMER YK-0810

**1200  
WATT**



ITEM CODE	8518DH
FREQUENCY	50Hz
INPUT POWER	1200W
NO LOAD SPEED	4200BPM
WHEEL DIAMETER	HEX 17MM

## DEMOLITION HAMMER YK-0835

**1200  
WATT**

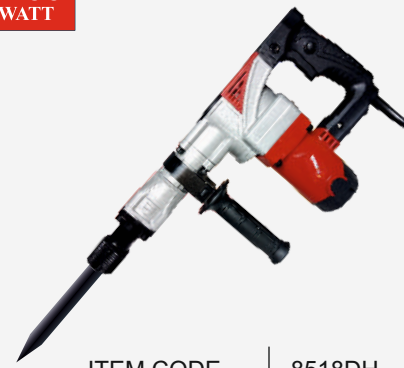

ITEM CODE	8518DH
FREQUENCY	50Hz
INPUT POWER	1200W
NO LOAD SPEED	4200BPM
WHEEL DIAMETER	HEX 17MM

## ANGLE GRINDER YK805

**1050**  
WATT



ITEM CODE	8521
FREQUENCY	50/60HZ
VOLTAGE	220/240V
INPUT POWER	1050 W
NO LOAD SPEED	11000 RPM
WHEEL DIAMETER	100 MM

## MARBLE CUTTER YK-CM4SA HQ

**1050**  
WATT



ITEM CODE	8035
FREQUENCY	50Hz
INPUT POWER	1050W
NO LOAD SPEED	11000r/min
WHEEL DIAMETER	110MM

## MARBLE CUTTER YK-CM5

**1600**  
WATT



ITEM CODE	8037
FREQUENCY	50Hz
INPUT POWER	1600W
NO LOAD SPEED	11000r/min
WHEEL DIAMETER	120MM

## ANGLE GRINDER GOLD AG-125

**1050**  
WATT



ITEM CODE	0836
FREQUENCY	50/60HZ
VOLTAGE	220/240V
INPUT POWER	1050 W
NO LOAD SPEED	11000 RPM
WHEEL DIAMETER	100 MM





## YK-PRO-801 PRO ANGLE GRINDER



ITEM CODE	9501
FREQUENCY	50/60HZ
VOLTAGE	220/230V
INPUT POWER	1100 W
NO LOAD SPEED	11000
WHEEL DIAMETER	100

## YK-PRO-CS16 16" CHAIN SAW



ITEM CODE	9506
FREQUENCY	50-60 HZ
INPUT POWER	1400 RPM
ROTATING SPEED	600 M/MIN
CUTTING LENGTH	395 MM

## YK-PRO-11E DEMOLITION HAMMER



ITEM CODE	9507
FREQUENCY	50/60HZ
NO LOAD SPEED	900-1890 RPM
INPUT POWER	1680 W
VOLTAGE	220/230 V

## YK-PRO-1800 PRO HEAT GUN



ITEM CODE	9505
FREQUENCY	50/60HZ
INPUT POWER	1600 W
TEMPERATURE	350-600 C
AIR VOLUME	250/500L/MIN

## YK-PRO-5800 GASOLINE CHAIN SAW 22"



ITEM CODE	9510
NO LOAD SPEED	2800 RPM
OUTPUT POWER	2600 W
SKID LENGTH	559MM (22")
TWO STROKE DISPLACEMENT	58CC
OIL TANK	0.26L
FUEL TANK	0.55L

## YK-PRO-65SC DEMOLITION HAMMER PH



ITEM CODE	9509
NO LOAD SPEED	1400 RPM
INPUT POWER	1700W
TOOL HOLDER	HEX 30 MM
VOLTAGE	220-240V
FREQUENCY	50/60HZ

**YK-PRO-600 PRO BLOWER**



ITEM CODE	9504
FREQUENCY	50-60 HZ
NO LOAD SPEED	0-16000RPM
INPUT POWER	600 W
AIR VOLUME	3.5 M/MIN
VOLTAGE	220-240V

**YK-PRO-0835 DEMOLITION HAMMER**



ITEM CODE	9508
BLADE DIAMETER	65 MM
INPUT POWER	1200 W
NO LOAD SPEED	3000 RPM
VOLTAGE	220/230 V
FREQUENCY	50/60HZ

**YK PRO 9182 ELECTRIC PLANER**



ITEM CODE	9182
FREQUENCY	50/60HZ
VOLTAGE	220/240V
INPUT POWER	16500
NO LOAD SPEED	1250
PLANING SIZE	82X2MM

**YK-CV1650 CONCRETE VIBRATOR**



ITEM CODE	9015
FREQUENCY	50-60Hz
VOLTAGE	220-230v
INPUT POWER	1650w
NO LOAD SPEED	4000r/min
VIBRATING ROD SIZE	35mm

**YK-MT950 PAINT MIXER**



ITEM CODE	9016
FREQUENCY	50-60Hz
VOLTAGE	220-240v
INPUT POWER	950w
NO LOAD SPEED	0-900r/min
MIXING PLATE	120mm

**YK-PRO-2-26 ROTARY HAMMER**



ITEM CODE	9512
FREQUENCY	50/60HZ
VOLTAGE	220/240V
INPUT POWER	800 W
NO LOAD SPEED	1100 RPM
DRILLING CAPACITY	26 MM



## POWER TOOLS

DEMOLITION HAMMER YK-0810



ITEM CODE	9183
BLADE DIAMETER	65 MM
INPUT POWER	1400 W
NO LOAD SPPED	3900 RPM
VOLTAGE	220/230 V
FREQUENCY	50/60HZ

DEMOLITION HAMMER YK-PRO-0835K



ITEM CODE	9184
BLADE DIAMETER	Q30 MM
INPUT POWER	1800 W
NO LOAD SPPED	4000 RPM
VOLTAGE	220/230 V
FREQUENCY	50/60HZ

## PRO POWER TOOLS

YK-PRO+0835 Demolition Hammer 0835

**(NEW PRODUCT)**



ITEM CODE	1010
BLADE DIAMETER	65 MM
INPUT POWER	1200 W
NO LOAD SPPED	3000 RPM
VOLTAGE	220/230 V
FREQUENCY	50/60HZ

YK-PRO+65SC Demolition Hammer PH65SC

**(NEW PRODUCT)**



ITEM CODE	1011
BLADE DIAMETER	65 MM
INPUT POWER	1200 W
NO LOAD SPPED	3000 RPM
VOLTAGE	220/230 V
FREQUENCY	50/60HZ

Item Code: 8021



- SPECIFICATIONS -

**Black Double Net Cut Off Wheel**

Super thin fast cut cutting discs. Made of precious corundum. The high-performance for hard iron.  
Size : 4" / 5" / 7" / 9" / 12" / 14"

Item Code: 8022



- SPECIFICATIONS -

**Brown Double Net Cut Off Wheel**

Super thin fast cut cutting discs. Made of precious corundum. The high-performance for hard iron.  
Size : 4" / 5" / 7" / 9" / 12" / 14"

Item Code: 8023



- SPECIFICATIONS -

**Green D/ Net Cut Off Wheel**

Special discs for stainless steel & casting. Soft disc, Made of precious Corundum aggressive. Free from iron and sulphur.  
Size : 4" / 5" / 12" / 14"



Item Code: 8031



- SPECIFICATIONS -

**Black/Green DC Wheel**

General purpose disc for all metal grinding applications. Made of semi precious corundum. For maximum grinding performance.  
Size : 4" / 5" / 7"

Item Code : 8034



- SPECIFICATIONS -

**Yorker Pro Plus Cut off Wheel**

Super thin fast cut cutting discs. Made of precious corundum. The high-performance for hard iron & stainless steel  
Size : 4" / 5"

Item Code: 8036



- SPECIFICATIONS -

**4" Professional GC Wheel GRIT # 46 to 120**

Special discs for stainless steel Made of semi precious Corundum and aluminum oxide.



Item Code: 8029



- SPECIFICATIONS -

**Brownie Double Net Cut Off Wheel**

Super thin fast cut cutting discs. Made of precious corundum. The high-performance for hard iron.  
Size : 4"

(NEW PRODUCT)

Item Code: 8041



- SPECIFICATIONS -

**Pro Fiber Disc 125 mm**

Grit in : 24/36 / 50 / 60 / 80 / 100 / 120

(NEW PRODUCT)

Item Code: 8043



(New Quality)

- SPECIFICATIONS -

**Professional Flap Disc 100 mm**

Grit in : 60 / 80 / 100 / 120

(NEW PRODUCT)

Item Code: 9083



(New Quality)

- SPECIFICATIONS -

**Yorker Metal Cutting**

Grit in: 100



Item Code: 8042(b)

**- SPECIFICATIONS -**  
**Waterproof Abrasive Paper**  
 Size : 230x280mm

Item Code: 8043

**- SPECIFICATIONS -**  
**Flap Disc 100 mm**  
 Grit in : 60 / 80 / 100 / 120

Item Code: 8042(A)

**- SPECIFICATIONS -**  
**Velcro Sandpaper Blue Colour**  
 Grit in : 40 / 60 / 80 / 100 / 120

Made by super fine wool

Item Code: 8044

**- SPECIFICATIONS -**  
**Felt Buff Pad**  
 • Mirror Polishing • Marble Granite  
 • SS Steel, Iron Steel • Non Ferrous Wood, Plastic  
 100x4x16mm

Item Code: 8045

**- SPECIFICATIONS -**  
**Non Woven Pad**  
 Specially For Deburring & Fine Polishing on Wide Variety of Material Such As Stainless Steel, Titanium Alloy & Brass Parts.  
 100x15x16mm

Item Code: 8046

(Premium Quality)

**- SPECIFICATIONS -**  
**PVC Pad For Fibre Disc**

Item Code: 8048



- SPECIFICATIONS -  
**PVC Pad for Valcro Sandpaper**  
 Yorker - M10 / M14

Item Code: 8050



- SPECIFICATIONS -  
**Diamond Polish Pad 4"**  
 Grit Size : 0,1,2,3,4,5,6

Item Code: 8047



- SPECIFICATIONS -  
**PVC Pad for Valcro Sandpaper**  
 Eco - M10 / M14

Item Code: 8048 (T)



- SPECIFICATIONS -  
**Thin Pad**



## Polishing Products

Polishing Is The Process Of Creating A Smooth And Shiny Surface By Rubbing It Or By Applying A Chemical Treatment, Leaving A Clean Surface





Item Code: 8051

(With Tube Packing)



- SPECIFICATIONS -

**Hammer Drill Bits**

Size : 5x110 To 25x600

Item Code: 8052



- SPECIFICATIONS -

**Masonry Drill Bit**

Size : 3/16" to 1/2"

Provides incredible fast drilling and self centering

Capable of drilling at any angle



**SPEED POINT TIP**

Item Code: 8065

**Jobber**

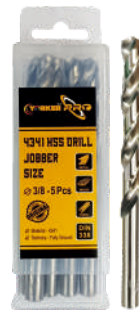

- SPECIFICATIONS -

**Yorker Pro HSS Drill Bit**

Material: 4341

Technics: Fully Ground

Jobber Size : 3/32" to 1/2"

Item Code: 8065A

**Stub**



- SPECIFICATIONS -

**Yorker Pro HSS Drill Bit**

Material: 4341

Technics: Fully Ground

Stub Size : 3/32" to 1/2"

Item Code: 8063



- SPECIFICATIONS -

**Golden HSS Drill Bit**

Jobber Size : 3/32" to 1/2"

Item Code: 8066



- SPECIFICATIONS -

**4 PCS Masonry Drill Bit**

Size : 1/4", 3/8", 3/16", 5/16"

Item Code: 8067



- SPECIFICATIONS -

**Yorker Step Drill**

Size : 4" 20mm/32mm



Item Code: 8071

**- SPECIFICATIONS -**  
**TCT Circular Saw Blade**  
 for Wood Cutting  
 4" x 30T to 14" x 120Tr

Item Code: 8175

**- SPECIFICATIONS -**  
**Aluminium Cutting TCT Saw Blade**  
 12" x100T / 120T  
 14" x100T / 120T

Item Code: 8074

**- SPECIFICATIONS -**  
**Yorker No.1 TCT**  
 4" x 30T / 40T  
 5" x 30T / 40T

Item Code: 8075

**- SPECIFICATIONS -**  
**Plus TCT Saw Blade**  
 4" x 30T / 40T  
 5" x 30T / 40T  
 6" x 40T

Item Code: 9040

**- SPECIFICATIONS -**  
**Yorker Tct Saw Blade**  
 4" x12T  
 5" x12T

Item Code: 8173

**- SPECIFICATIONS -**  
**Snick Thin Kerf**  
 4" x 30T / 40T  
 5" x 30T / 40T



# DIAMOND SAW BLADES

**Item Code: 8081**



**- SPECIFICATIONS -**  
**Eco Series Marble Blade**  
 4" x 9T / 16T / Rim / Turbo  
 5" x 9T / Rim

**Item Code: 8082**



**- SPECIFICATIONS -**  
**Marble Blade**  
 4" x 9T / 16T / Rim / Turbo  
 5" x 9T / Rim / Turbo, 6" x 12T  
 7" x 14T, 8" x 14T, 14" x 24T

**Item Code: 8083**



**- SPECIFICATIONS -**  
**Yorker Speed Marble Blade**  
 4" x 9T

**Item Code: 9070**



**- SPECIFICATIONS -**  
**Yorker 1008 Marble Blade**  
 4"x9T (Speed-13300 RPM)

**Item Code: 8086**  
 (NEW PACKING)



**- SPECIFICATIONS -**  
**Classic Yellow Marble Blade**  
 4" x 9T / 16T / Rim / Turbo  
 5" x 9T / Rim

**Item Code: 8088**



**- SPECIFICATIONS -**  
**Yorker Gold Marble Blade**  
 (500ft. Granite Cutting Guarantee)  
 Size : 4x9T/Rim/Turbo, 5x10T

**Item Code: 9070 (Y)**



**- SPECIFICATIONS -**  
**Y-series Eco Diamond Saw Blade**  
 Size: 4"x9T / Rim / Turbo  
 Size: 5"x9T / Rim / Turbo



**Item Code: 8090(A)**



**- SPECIFICATIONS -**  
**786 Hot Pressed Marble Blade**  
 4x10T, 25 Pcs PVC Box Packing

**Item Code: 8097**



**- SPECIFICATIONS -**  
**114mm Concrete Cutting Blade**  
 (1000ft. Granite Cutting Guarantee)  
 Size : 144mm x 8T



Item Code: 9001

NEW PRODUCT

(New Quality)

- SPECIFICATIONS -

Tiger Diamond Saw Blade  
4x8t, 5x9t

Item Code: 9044

NEW PRODUCT

(New Quality)

- SPECIFICATIONS -

Yorker Zzz Blade  
4x9t, 5x9t

Item Code: 9082

NEW PRODUCT

(New Quality)

- SPECIFICATIONS -

Yorker Glass Cutting  
Size- 4"

## CUP WHEELS

Item Code: 8101

- SPECIFICATIONS -

ECO Cup Wheel  
Size : 3" 8T Cut/Rim

Item Code: 8099

- SPECIFICATIONS -

Dual Flat Cup Wheel  
Size : 4"

Item Code: 8100

- SPECIFICATIONS -

Blister Cup Wheel  
Size : 3" Cut/Rim - 4" Cut

Item Code: 8099

(NEW ARRIVAL)

- SPECIFICATIONS -

Dual Flat Cup Wheel  
4" Dual cup  
Wheel 2in1

Item Code: 8105

(NEW ARRIVAL)

- SPECIFICATIONS -

Diamond Molding Wheel  
15mm, 20mm, 25mm,  
30mm, 35mm



Item Code: 8095



- SPECIFICATIONS -  
**Eco Super Thin Turbo**  
 Size : 4" Turbo



Item Code: 8097(P)



- SPECIFICATIONS -  
**Yorker Pro Ultra Super Thin Turbo**  
 4"(110mm) Turbo

Item Code: 8095(A)



- SPECIFICATIONS -  
**Eco Super Thin Mesh Turbo**  
 Size : 4" Mesh Turbo

Item Code: 8094



- SPECIFICATIONS -  
**Glass Cutting Blade**  
 (CD Blade)

Item Code: 8096(P)

(NEW PRODUCT)



(New Quality)  
 - SPECIFICATIONS -  
**Professional Flap Disc 100 mm**  
 Grit in : 60 / 80 / 100 / 120

## YORKER SUPER THIN TURBO BLADE

Yorker Super Thin Turbo blade has been developed using the hotpress technology that provides it with a great length of service. This high-powered industrial blade works to deliver smooth, chip-free and optimum results on the surface when used with compatible machines.





## ZERO CHIPPING BLADES

Item Code: 9014



- SPECIFICATIONS -

Yorker

Item Code: 9003



- SPECIFICATIONS -

Yorker Pro Ultra

## 114 mm CONCRETE BLADES

Item Code: 8097



- SPECIFICATIONS -

(1000ft. Granite Cutting Guarantee)  
Size : 144mm x 8T

Item Code: 8091



- SPECIFICATIONS -

(900ft. Granite Cutting Guarantee)  
Size: 114mm x 8T  
114mm x Turbo

Item Code: 8098



- SPECIFICATIONS -

(1800ft. Granite Cutting Guarantee)  
Size: 114mm x 8T

## ACCESSORIES

Item Code: 1055

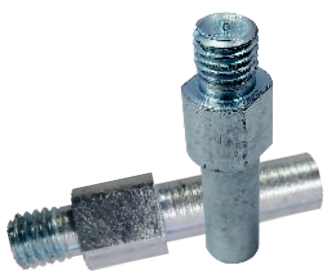

- SPECIFICATIONS -

Core bit Adapter

Item Code: 9099



- SPECIFICATIONS -

Yorker Teflon Tape  
10mtr

Item Code: 7101

NEW PRODUCT



- SPECIFICATIONS -

Water Pump Plier  
Hardend & Tempered

Item Code: 9001



- SPECIFICATIONS -

**Yorker 101**  
Size : 4", 6" (2in1)

Item Code: 9002



- SPECIFICATIONS -

**Yorker 102**  
Size : 4", 6", 8", 10", 12" (2in1)

Item Code: 9003



- SPECIFICATIONS -

**Yorker 103**  
Size : 4", 6" (2in1)

Item Code: 9012



- SPECIFICATIONS -

**key type**  
(2 in 1)

Item Code: 9004



- SPECIFICATIONS -

**Red Hammery**

Item Code: 9005



- SPECIFICATIONS -

**Yorker 105**  
(With Hammering)  
Size : 4", 6", 8", 10", 12" (2in1)

Item Code: 9008



- SPECIFICATIONS -

**Screw Driver Set**



Item Code: 9011



- SPECIFICATIONS -

**Stubby Driver Set**  
3" (2 in 1) 75mm

Item Code: 9010



- SPECIFICATIONS -

**Yorker Pro**  
(yellow Black)

Item Code: 9021



- SPECIFICATIONS -

**Deep Hole Saw for Wood**  
Size : 35/50/54/57/64/75 mm

Item Code : E-9022



- SPECIFICATIONS -

**Eco Planer Blade**  
HCS Quality

Item Code : H-9022



- SPECIFICATIONS -

**Planer Blade**  
SKH / HSS Quality

Item Code : T-9022



- SPECIFICATIONS -

**Pro Planer Blade**  
TCT Quality

Item Code: 9026



- SPECIFICATIONS -

**Wooden Hole Saw Sets**  
6 / 8 / 11 / 12 / 16 Pcs.

Item Code: 9027



- SPECIFICATIONS -

**Wood Flat Bits**  
1 Pc. Skin Card Packing  
10mm to 38mm

Item Code: 9028



- SPECIFICATIONS -

**6 Pc. Wood Flat Bits**

Item Code: 9041



- SPECIFICATIONS -

**Router bits**  
Size : All Sizes



Item Code : 9007



- SPECIFICATIONS -

**Yorker Claw Hammer**  
250gm,450gm,450gm(Red)

Item Code: 9037



- SPECIFICATIONS -

**Wooden Chisel**  
Size: 1", 1-1/4", 1-1/2"



Item Code: 9031



- SPECIFICATIONS -

**Eco Series**  
Caulking Gun (Silicon Gun)

Item Code: 9032



- SPECIFICATIONS -

**Yorker Series**  
Caulking Gun (Silicon Gun)

Item Code: 9033



- SPECIFICATIONS -

**Yorker Gold**  
Caulking Gun (Silicon Gun)

Item Code: 9034



- SPECIFICATIONS -

**Yorker Professional**  
Caulking Gun (Silicon Gun)

Item Code: 9040



- SPECIFICATIONS -

**PVC**  
Caulking Gun (Silicon Gun)

Item Code: 9034(F)



- SPECIFICATIONS -

**Fischer Gun**  
Fischer (Caulking Gun)

Item Code: 9131



- SPECIFICATIONS -

**Yorker Grease Gun**  
(Lever Grease Gun)

Item Code: 9038(B)



- SPECIFICATIONS -

**901 Screw Driver Bits**  
Taiwan S2 Material

Item Code: 9038



- SPECIFICATIONS -

**Professional Ph2 Bit**  
Size : 50mm / 65mm / 100mm / 150mm

Item Code: 9037



- SPECIFICATIONS -

**Yorker Gold Ph2 Bit with Positioner**  
Size : 65mm / 100mm

Item Code: 9038(R)



- SPECIFICATIONS -

**Professional Ph2 Bit Ringhead**  
Size : 65mm



Item Code: 9036

- SPECIFICATIONS -  
**Gold Screw Driver Bit**  
 65 / 100 / 150mm Ph2, 65mm PHZ

Item Code: 9042

- SPECIFICATIONS -  
**High Carbon Flexible Hacksaw Blade**  
 Weight : 1.600g approx  
 12"x 1/2"x24"/24T  
 12"x 1"x24"/24T  
 12"x 1"x24"/18T

Item Code: 9042(A)

- SPECIFICATIONS -  
**High Carbon Hard Hacksaw Blade**  
 (Black / Yellow)  
 Weight : 1.700g approx  
 12"x 1/2"x24T  
 12"x 1"x24T/24T

Item Code: 9042(B)

- SPECIFICATIONS -  
**All Hard hacksaw Blade (Multi-Color)**  
 Size : 1" Double

Item Code: 9129(B)

- SPECIFICATIONS -  
**Dwall Combination Plier**  
 Size : 205mm

Item Code: 9049

- SPECIFICATIONS -  
**Combination Plier 8" (Drop Forged)**  
 with Heavy Quality Sleeves

Item Code: 9049(B)

- SPECIFICATIONS -  
**Yorker Gold Plier 8"**

Item Code: 9129(W)

- SPECIFICATIONS -  
**Wire Stripper & Cutter**  
 Size : 132mm

Item Code: 9129

- SPECIFICATIONS -  
**10 Inch Katiya Cutter**  
 Size : 10"

Item Code: 9046

- SPECIFICATIONS -  
**Eco Tin Snip 10"**

Item Code: 9047

- SPECIFICATIONS -  
**Gold CRV Tin Snip 10"**

Item Code: 9048

- SPECIFICATIONS -  
**Professional Tin Snip 10"**

Item Code: 0003

- SPECIFICATIONS -  
**Yorker Bolt Cutter**

Item Code: 9051

- SPECIFICATIONS -  
**Magnet Level**  
 Size : 12" / 18" / 24"

Item Code: 9050B

- SPECIFICATIONS -  
**Yorker Torpedo Level**  
 Magnet Level ( Size : 8" )

Item Code: 9052

- SPECIFICATIONS -  
**Magnet Level**  
 Size : 12"

Item Code: 9013



- SPECIFICATIONS -  
**Paint Mixer Rod**  
 Type : Fan/Spiral Type

Item Code: 9058



- SPECIFICATIONS -  
**Saw Chain**  
 Size : 16"/18"/20"/22"

Item Code: 9058(P)



- SPECIFICATIONS -  
**Professional Saw Chain**  
 Size : 16"/18"/20"/22"

Item Code : 9017



- SPECIFICATIONS -  
**Yorker Professional Saw Chain**  
 Sizes : 18" / 22"

Item Code: 9061



- SPECIFICATIONS -  
**Concrete Hole Saw Handle**  
 Size : 250 / 400mm

Item Code: 9062



- SPECIFICATIONS -  
**Pointed & Flat Chisel**  
 Size : 14x250,17x280,18x450,18x450x75,  
 18x300x75,18x400x18x600,30x400

Item Code: 9060



- SPECIFICATIONS -  
**Concrete Hole Saw**  
 Size : 50/65/75mm

Item Code: 9063(E)



- SPECIFICATIONS -  
**PVC Pipe Cutter Eco**

Item Code: 9063



- SPECIFICATIONS -  
**PVC Pipe Cutter**

Item Code: 9067



- SPECIFICATIONS -  
**Combination Stone**  
 Size : 6" / 8"

Item Code: 9067(A)



- SPECIFICATIONS -  
**SL. Carborundum**  
 Size : 6" / 8"

Item Code: 9068



- SPECIFICATIONS -  
**Diamond Polish Stone**

Item Code: 9065



- SPECIFICATIONS -  
**SDS Adaptor**

Item Code: 9071



- SPECIFICATIONS -  
**Drill Chuck**  
 Size : 10 / 13mm

Item Code: 9045



- SPECIFICATIONS -  
**Magnetic Nut Runner**  
 Size : 8x42/65, 10x65

Item Code: 9045(P)



NEW PACKING  
 - SPECIFICATIONS -  
**Magnetic Nut Runner Pro**  
 Size : 8x65mm

Item Code: 9039  
(NEW PACKING)

**(New Quality)**  
- SPECIFICATIONS -  
**Carbide Glass Drill**  
6 / 8 / 10 mm

Item Code: 9132

- SPECIFICATIONS -  
**Yorker Suction Cup**  
Size : GSL 1/2/3

Item Code: 9072

- SPECIFICATIONS -  
**Drill Chuck Key**  
Size : 10mm / 13mm

Item Code: 9073

- SPECIFICATIONS -  
**Angle Grinder Key**  
Size : 6-100/801 Key

Item Code: 9057

- SPECIFICATIONS -  
**Zig Saw Blade**  
Size : T144D/144D/T244D

Item Code: 9074

- SPECIFICATIONS -  
**CM-4 Key Set & L Bolt**

Item Code: 9075

- SPECIFICATIONS -  
**Tile Cutter**  
Single Pcs. Packing

Item Code: 9076

- SPECIFICATIONS -  
**Tile Cutter**  
with 5 Pcs. Pin Extra

Item Code: 9078

- SPECIFICATIONS -  
**Dwall Glass Cutter (M)**  
(with 12 Pcs. Box Packing)

Item Code: 9079

- SPECIFICATIONS -  
**Glass Cutter**  
Transparent Body

Item Code: 9080

- SPECIFICATIONS -  
**Glass Cutter**  
Aluminium Body

Item Code: 9081

- SPECIFICATIONS -  
**Sunmica Cutter**  
with Colour Box

Item Code: 9066

- SPECIFICATIONS -  
**9 Pcs. Hex Key Wrench**

Item Code: 9020

- SPECIFICATIONS -  
**Timmer Router Bits set**  
Size : All Sizes



Item Code: 9091



- SPECIFICATIONS -

**Yorker Cup Brush**

Size : 3" M-10 / 4" M-14

Item Code: 9091-C



- SPECIFICATIONS -

**Yorker Crimped Brush**

Size: 3" Crimped, 4" Crimped

Item Code: 9093



- SPECIFICATIONS -

**Professional Cup Brush**

Size: 3" Heavy, 4" Heavy

Item Code: 9094



- SPECIFICATIONS -

**CARBON BRUSHES**

801, DU-10, PD-100, 2-20, CM-4, O810

LG3555, PH-65, GLO-2000, 11E, 2-26, MT-410, 6-100

Item Code: 9095



- SPECIFICATIONS -

**AB WASHER**

CM-4, 6100, 801, Mt410, CM-5

Item Code: 9098



- SPECIFICATIONS -

**Gear**

CM-4, 6-100, DW-801

Item Code: 9099



- SPECIFICATIONS -

**ARMATURE**

801, DU-10, PD-100, 2-20, CM-4, O810

LG3555, PH-65, GLO-2000, 11E, 2-26, MT-410, 6-100

Item Code: 9100



- SPECIFICATIONS -

**DIAMOND CORE BIT**

6.5, 8.5, 10, 12, 14, 16, 19, 20, 22, 26, 33, 37, 40, 50mm

Item Code: 9056



- SPECIFICATIONS -

**Hand Saw**

Size: 16" , 18" , 20" , 24"

Item Code: 9056 (B)



- SPECIFICATIONS -

**Masonry Saw**

Size: 24" , 30"

Item Code: 9059



- SPECIFICATIONS -

**Yorker Pruning Saw**

Size: 12" (300mm)



Item Code: Gt01



- SPECIFICATIONS -  
**SCISSOR TYPE**

Item Code: Gt02



- SPECIFICATIONS -  
**FLOWER CUTTER  
ECO**

Item Code: Gt03



- SPECIFICATIONS -  
**FLOWER CUTTER  
GOLDEN COLOUR**

Item Code: Gt04



- SPECIFICATIONS -  
**FLOWER CUTTER  
HEAVY QUALITY**

Item Code: Gt05



- SPECIFICATIONS -  
**LEVER SPRAY HEAVY**

Item Code: Gt06



- SPECIFICATIONS -  
**LEVER SPRAY ECO**

Item Code: Gt07



- SPECIFICATIONS -  
**PRUNING SAW  
270MM**

Item Code: Gt08



- SPECIFICATIONS -  
**PRUNING SAW  
350MM**

Item Code: Gt09



- SPECIFICATIONS -  
**GRASS CUTTER  
BLADE**

Item Code: GT-04

**NEW PRODUCT**



- SPECIFICATIONS -

**Fork Dual**

Item Code: GT-14

**NEW PRODUCT**



- SPECIFICATIONS -

**Fork 9 Teeth**

Item Code: GT-15

**NEW PRODUCT**



- SPECIFICATIONS -

**Fork 3 Claws**

Item Code: GT-05

**NEW PRODUCT**



- SPECIFICATIONS -

**Fork 5 Teeth**

Item Code: GT-11

**NEW PRODUCT**



- SPECIFICATIONS -

**Fork 3 Prong**

Item Code: GT-12

**NEW PRODUCT**



- SPECIFICATIONS -

**Mini Round Spade**

Item Code: GT-13

**NEW PRODUCT**



- SPECIFICATIONS -

**Mini Spade**

Item Code: GT 17

**NEW PRODUCT**



- SPECIFICATIONS -

**Professional Garden Saw**



Item Code: 9025

NEW PRODUCT



- SPECIFICATIONS -

**Yorker PvC Hammer**

Size: 320gm, 380gm, 480gm, 610gm

Item Code: 9040

NEW PRODUCT



- SPECIFICATIONS -

**Yorker TcT Hole Saw**

Size: 16mm To 65mm

Item Code: 9041

NEW PRODUCT



- SPECIFICATIONS -

**Four Slot Auger Bit**

Size: 12mm To 38mm

Item Code: 9043

NEW PRODUCT



- SPECIFICATIONS -

**Yorker Hand Riveter Professional**

Size: 10.5,17

Item Code: 9024

NEW PRODUCT



- SPECIFICATIONS -

**Yorker Glue Gun**

9" Dual Purpose Gun

Item Code: 9090

NEW PRODUCT



- SPECIFICATIONS -

**Yorker Hammer**

Size: 500gm, 300gm, 200gm,

Item Code:9020

NEW PRODUCT



- SPECIFICATIONS -

**PVC  
Caulking Gun (Silicon Gun)  
Eco Gun**

Item Code:9020

NEW PRODUCT



- SPECIFICATIONS -

**PVC  
Caulking Gun (Silicon Gun)  
Yorker Gun**

Item Code:0004

NEW PRODUCT



- SPECIFICATIONS -

**Flat Bastard**  
Size: 6",8", 10" 12"

Item Code:0005

NEW PRODUCT



- SPECIFICATIONS -

**Flat Bastard**  
Size: 6",8", 10" 12"

Item Code: 7100

NEW PRODUCT



- SPECIFICATIONS -

### Hacksaw Freme

Size: 12"

Item Code: 7102

NEW PRODUCT



- SPECIFICATIONS -

### Pip Wrench

Size: 10", 12", 14", 18", 24"

Item Code: 0006

NEW PRODUCT



- SPECIFICATIONS -

### Diamond Files

Size: 3X140mm, 4X160mm, 5X180mm

Item Code: 0006

NEW PRODUCT



- SPECIFICATIONS -

### Diamond Files

Size: 12"







**YORKER TOOLS CENTRE**  
New Delhi - INDIA

E-mail : [officeyorker@gmail.com](mailto:officeyorker@gmail.com)

   /Yorker Tools